

产品规格说明书

T-N-1212CCNC
(TPD 1212 共阴铜支架)

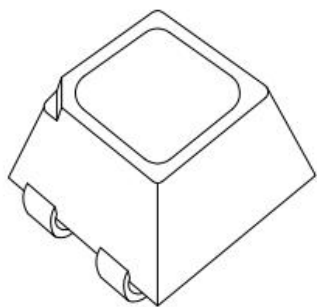

TOPDA
拓普达

规格书

SPECIFICATION

客户名称 Customer Name	
产品型号 Product Type	T-N-1212CCNC (TPD 1212 共阴铜支架)
产品描述 Product Description	1212 户内全彩 SMD LED



客户确认 Customer Confirm			拓普达光电研发中心 T&D Center		
核准 Confirm	审核 Approve	确认 Check	核准 Confirm	审核 Approve	制作 Draw
版次/Version NO: A			发行日期/Release Date: 2024年10月06日		

目 录

SPECIFICATION	2
1.产品型号/Product Type:	4
2.产品简介/Product Introduction:	4
3.产品特点/Product Features:	5
4.产品应用/Product Application:	5
5.产品规格/Product Specification Drawing:	6
6.主要的光电特性参数表/ Electrical/Optical Characteristics (TA=25°C)	7
7.最大限度规格/ Absolute Maximum Ratings (TA=25°C)	7
8.典型的光-电曲线图/ Typical Characteristics Curves:	9
9.信赖性测试/ Reliability Test Items And Conditions	10
10.包装/Package:	11
10.1.载带/Tape:	11
10.2.包装-载带装填/Trailer and Leader:	11
10.3.防静电真空包装/Moisture-Proof & Antistatic Foil Bag Package:	11
10.4.标签说明/Label State:	12
10.5.外箱包装/Carton Package:	12
11.焊接建议/Recommended Soldering Condition:	13
11.1.回流焊接：建议按以下温度曲线图进行/Recommended Reflow Soldering Condition	13
11.2.使用烙铁人手焊接/ Recommended Hand Soldering Condition	14
12.使用注意事项/Precautions for use	14
12.1.清洁方法/ Clean method	14
12.2.防潮湿包装方法/ Moisture proof packaging method	14
12.3.储存及使用方法/ Storage and method of application	15
12.4.静电/ Static Electricity	15
12.5.温度保护/ The safe temperature for LEDs working	16
12.6.反向电压控制/ Reverse voltage Control	16
修订记录 Revision History	17

1.产品型号/Product Type:

T-N-1212CCNC

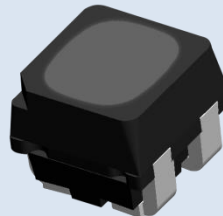

2.产品简介/Product Introduction:

本产品为 RGB 全彩，表面贴装器件。杯体采用全黑 PPA，户外级防护胶水并黑化哑光处理，具有高可靠性、长寿命、宽视角、高对比度等特点，是显示/装饰的理想选择。

These products are full-color SMD components with full black frame, high contrast , black and matt packaging and non-mirror reflection, which are featured by good reliability, long lifespan and wide viewing angle.They are designed for indoor display and decoration applications.

3.产品特点/Product Features:

- ◇ 发光颜色: RGB 三色
Emitting color: RGB full-color
- ◇ 芯片材质: R:AlGaInP /G: InGaN /B: InGaN
Chip material : R:AlGaInP /G: InGaN /B: InGaN
- ◇ 1.25 mm×1.22 mm×0.85 mm 表面贴片发光二极管
1.25 mm×1.22 mm×0.85 mm TOP LED
- ◇ 视角度: 100°
View angle:100°
- ◇ 封装材料: 环氧树脂
Encapsulation: Epoxy resin
- ◇ 焊接方法: 有铅&无铅 回流焊
Soldering methods: Pb&Pb-Free reflow soldering
- ◇ 光强度高, 功耗低, 可靠性好, 寿命长, 高对比度
High luminous intensity ,Low power dissipation, Good reliability and long life

4.产品应用/Product Application:

- ◇ 室内显示屏
Indoor full-color video screen
- ◇ 室内照明
Indoor lighting
- ◇ 液晶背光源
Liquid crystal backlight
- ◇ 装饰照明
Decorative lighting

5.产品规格/Product Specification Drawing:

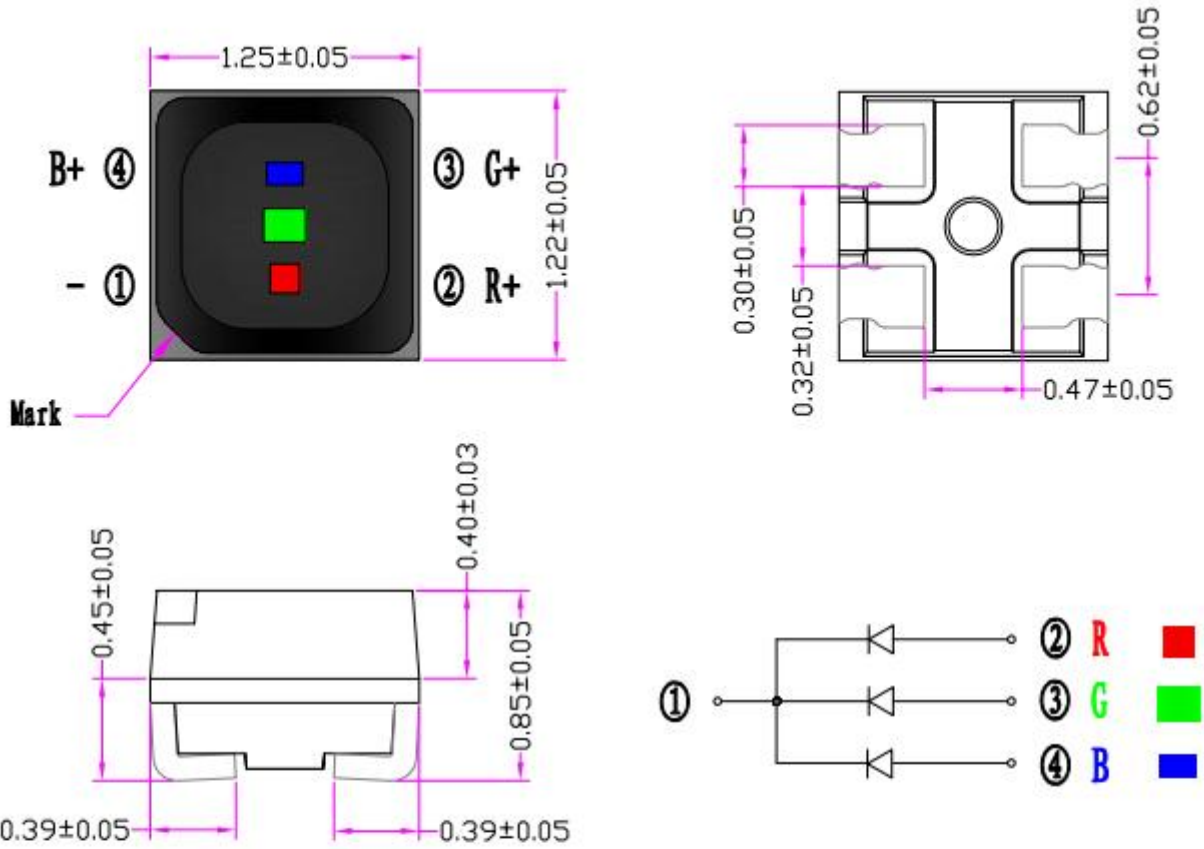

参考焊盘 soldering pad (for reference):

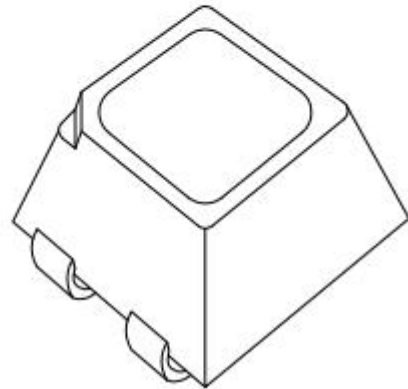
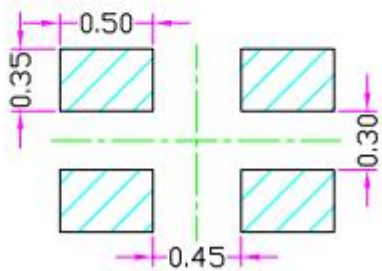

备注/Remarks:

所有尺寸单位为 mm, 未特别标注的情况下所有尺寸公差为 ± 0.05 毫米

All dimensions in mm, The tolerance is 0.05mm if no additional special remarks.

6. 主要的光电特性参数表/ Electrical/Optical Characteristics (TA=25°C) :

发光色 Color	波长 (nm) Dominant Wavelength			发光强度(mcd) Luminous Intensity(mcd)			反向电流 IR (μA) Reverse Current (μA)	测试条件 Test Condition	发光角度 View Angel	正向电压 Forward Voltage(v)
	最小值 Min.	典型值 Typ.	最大值 Max.	最小值 Min.	典型值 Typ.	最大值 Max.	V _R = 9V			
Red	618	622	625	14	20	30	0.2	I _F = 5mA	100	1.8-2.4
Green	520	526	532	45	65	85	0.2	I _F = 3mA	100	2.4-3.2
Blue	462	468	474	7	9	15	0.2	I _F = 2mA	100	2.5-3.3

7. 最大限度规格/ Absolute Maximum Ratings (TA=25°C) :

项目 Parameter	符号 Symbol	最大限度规格 Maximum Ratings			单位 Unit
		R	G	B	
正向电流/ Forward current	I _F	15	15	15	mA
峰值正向电流/ Peak forward current	I _{FP}	25	20	20	mA
反向电压/ Reverse voltage	V _R	5	5	5	V
消耗功率/ Power dissipation	P _D	36	48	48	mW
工作温度/ Working temperature	Topr	-40 ~ +85			°C
贮存温度/ Storage temperature	Tstg	-40 ~ +85			°C
回流焊温度/ Reflow temperature	Tsol	Max.250°C			for 10 sec.

注意事项/Note:

- 1) 产品光电性能等级由我司自行决定，各不同等级的产品光电性能有所差异，请客户根据己方使用条件自行决定使用方法。

The parameters above only for your reference. In case of any discrepancy, please adhere to the label of our actual products.

- 2) 发光强度的测量公差为：±10%.

Tolerance of measurements of the luminous intensity is ± 10%

- 3) 正向电压测量公差为：±0.1V.

Tolerance of measurements of the forward voltage is ± 0.1V

- 4) 对于如何安全使用请参阅第 13-15 页。

Please refer to page13 to page 15 for how to use product safely

- 5) 我们一直在努力提升 LED 产品的性能，规格如有变更，另行通知。

We are improving our products always, If there are any changes to the specifications, will notice separately

8.典型的光-电曲线图/ Typical Characteristics Curves:

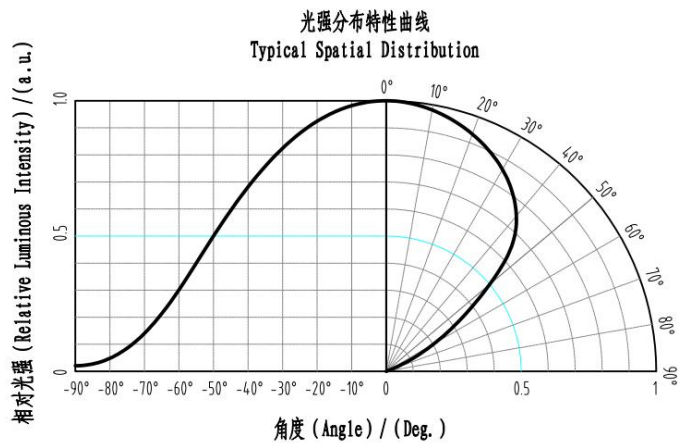
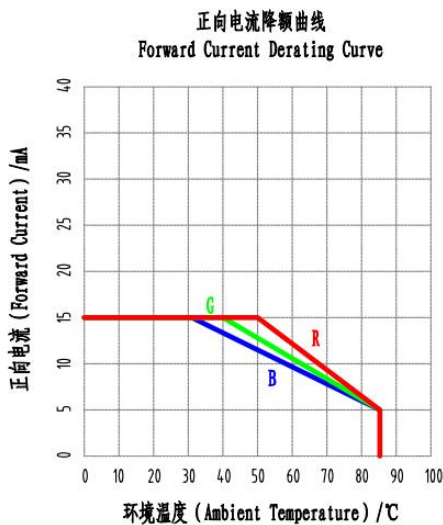
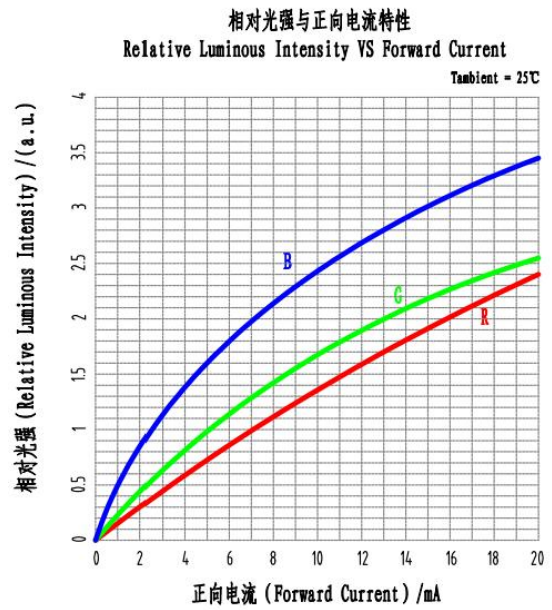
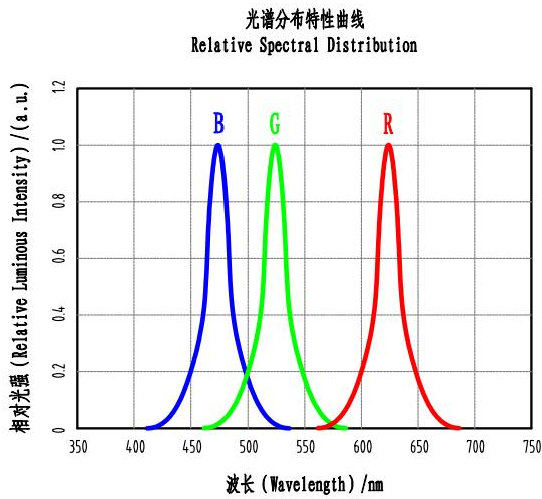
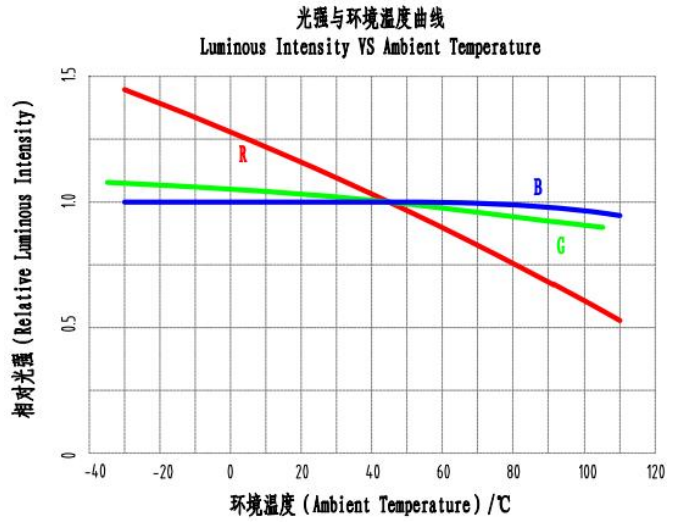
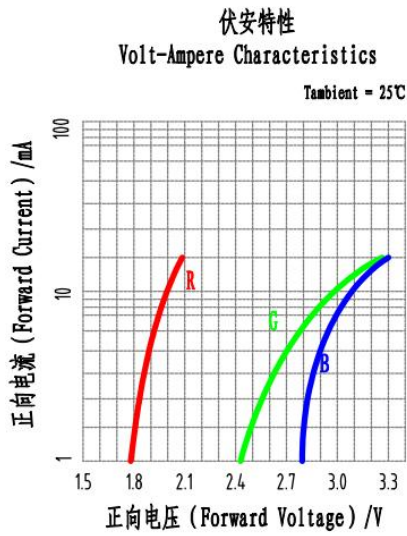

9. 信赖性测试/ Reliability Test Items And Conditions:

项目 Test Items	参考标准 Reference	实验条件 Test Conditions	时间 Time	样品数 Quantity	判断标准 Criterion
防水实验 Water proof test	--	过回流后, 红墨水浸泡 Immersing in red water after reflow	24H	100	0/100
冷热冲击 Thermal shock	MIL-STD-202G	-40°C(15min) ~ 125°C(15min)	200 Cycles	144	0/144
高温储存 High temperature storage	JEITA-ED-4701 200 201	Ta=100°C	1000H	100	0/100
低温储存 Cryogenic storage	JEITA-ED-4701 200 202	Ta= -40°C	1000H	100	0/100
常温寿命 Life test	--	Ta=25°C IFR=5mA, IFG=3mA, IFB=2mA	1000H	20	相对初始值: Vf ± 10%; IR ≤ 15μA; 平均 IV 衰减 ≤ 30%; 红光 IV 衰减 ≤ 20%; 绿光 IV 衰减 ≤ 20%; 蓝光 IV 衰减 ≤ 50%
耐焊接热 Resistance to soldering heat	--	Tsol*=250°C 10sec.	2 Times	144	0/144

10.包装/Package:

10.1.载带/Tape:

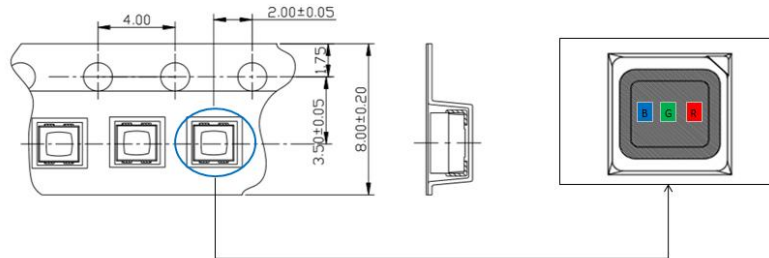

10.2.包装-载带装填/Trailer And Leader:

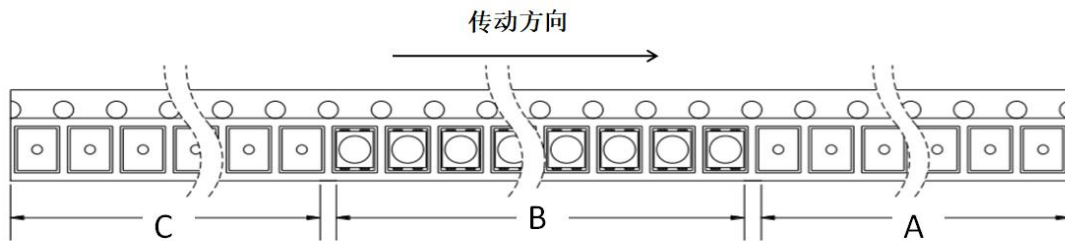

- A: 前空 (头部), 400mm;
- B: 装料 40000 颗/盘;
- C: 后空(尾部), 160mm
- A: Leader empty, 400mm;
- B: 40000 PCS Loaded;
- C: Trailer empty, 160mm

10.3.防静电真空包装/Moisture-Proof & Antistatic Foil Bag Package:

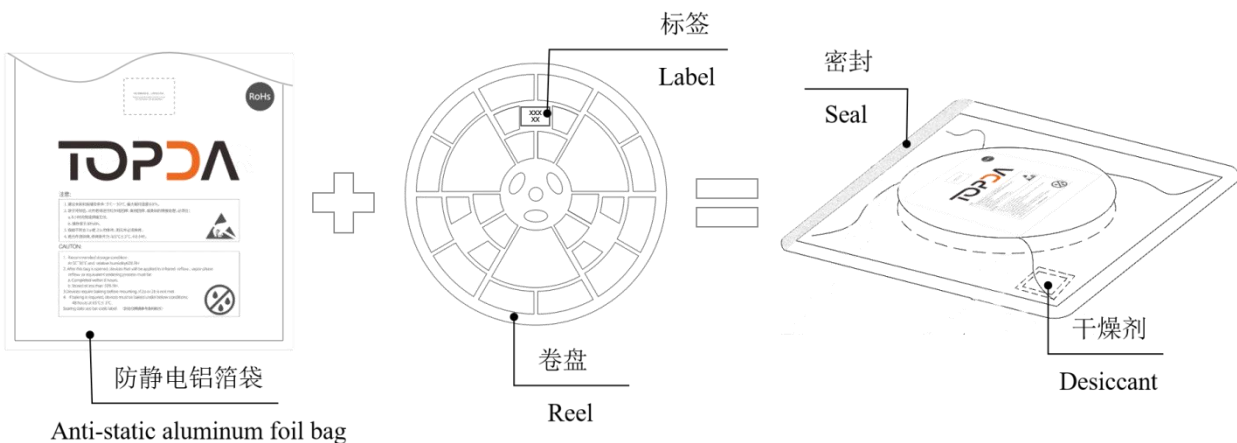

防静电铝箔袋 *1
Antistatic foil bag *1

40000/盘 *2
40000 PCS/Reel*2

80000 PCS/袋
80000 PCS/Bag

10.4. 标签说明/Label State:



标签说明/Label State:

- ◇ Type: Product Type 产品型号
- ◇ Lot No: Lot Number 产品批号
- ◇ VF: Forward Voltage Range 正向电压范围
- ◇ IV: Luminous Intensity Range 光强范围
- ◇ WL: Wavelength Range 波长范围
- ◇ QTY: Quantity 数量
- ◇ Date: Production Date 生产日期

10.5. 外箱包装/Carton Package:

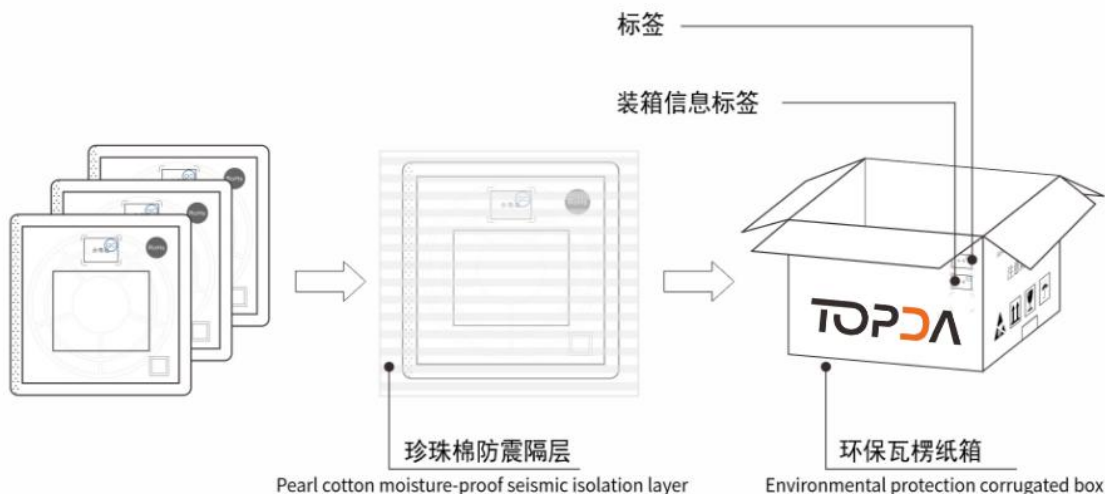

10 袋, 20 盘, 共 800000 PCS/箱
 10 Bags, 20 Reels, 800000 PCS/Carton

11.焊接建议/Recommended Soldering Condition:

11.1.回流焊接: 建议按以下温度曲线图进行/Recommended Reflow Soldering Condition:

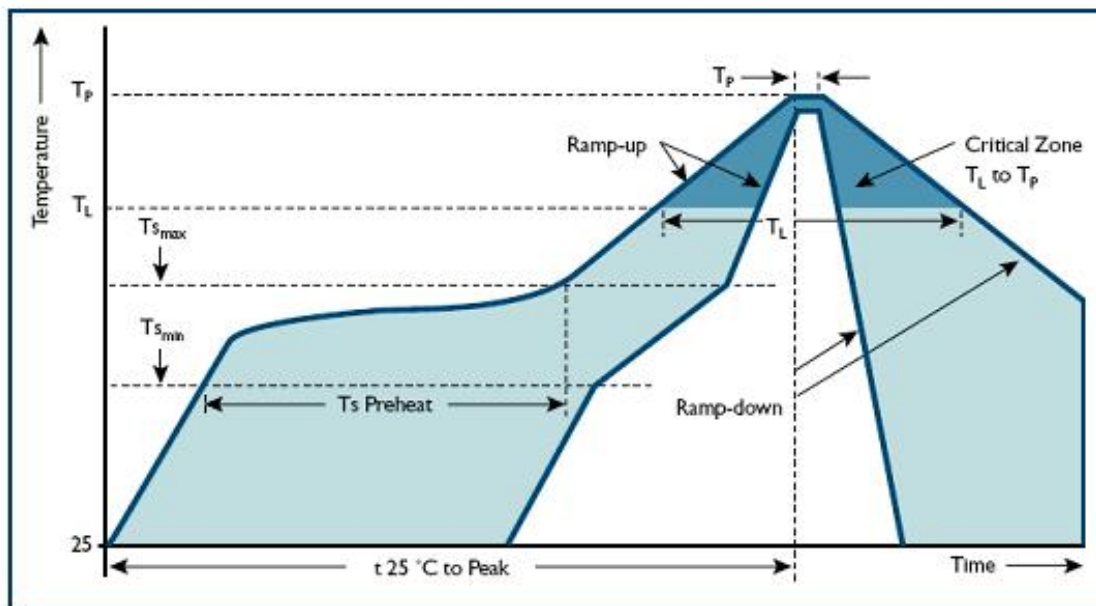

有铅锡/Lead Solder	无铅锡/Lead-free Solder
温度上升斜率 Tsmax to TP= 3°C/s 最大 Temperature rise slope Tsmax to TP= 3°C/s (Max)	温度上升斜率 Tsmax to TP=3°C/s 最大 Temperature rise slope Tsmax to TP=3°C/s (Max)
预热温度 Tsmm= 100°C~150°C Preheating temperature Tsmm= 100°C~150°C	预热温度 Tsmm= 150°C~200°C Preheating temperature Tsmm = 150°C~200°C
预热时间 Tsmm to Tsmax = 100s 最大 Preheating time Tsmm to Tsmax = 100s (Max)	预热时间 Tsmm to Tsmax = 100s 最大 Preheating time Tsmm to Tsmax = 100s (Max)
温度下降斜率为 5°C/s 最大 Temperature down slope 5°C/s (Max)	温度下降斜率为 5°C/s 最大 Temperature down slope 5°C/s (Max)
峰值温度 TP = 220°C 最大 Peak temperature TP = 220°C (Max)	峰值温度 TP = 250°C 最大 Peak temperature TP = 250°C (Max)
在峰值温度±5°C时间不能超过 10s Time at peak temperature ± 5 °C shall not exceed 10s	在峰值温度±5°C时间不能超过 10s Time at peak temperature ± 5 °C shall not exceed 10s
超过 183°C的温度的时间不能超过 80s The time of temperature exceeding 183 °C shall not exceed 80s.	超过 217°C 的温度的时间不能超过 45s The time of temperature exceeding 217 °C shall not exceed 45s.

注意/ Note:

1).焊接回流时不能对灯珠施加外力，施加外力会损害灯珠。

Stress on the LEDs should be avoided during heating in the reflow soldering process.

2).回流焊只能进行一次。

Reflow soldering should not be done more than one time.

3).在焊接之后，要让它自然冷却后才能进行其他作业。

After soldering, do not deal with the product before its temperature drop down to room temperature

11.2.使用烙铁人手焊接/ Recommended Hand Soldering Condition:

11.2.1.如使用手工焊接，建议使用小于 25 瓦的电烙铁，烙铁温度必须控制在 315°C以下，焊接时间不能超过 2 秒。手工焊接时电烙铁不可触及 SMD LED 表面。

If manual soldering is used, the use of a soldering iron of less than 25W is recommended. The temperature of the iron must be kept below 315°C,with soldering time within 3 seconds and each electrode can be only soldered at one time.

11.2.2.烙铁不能接触到支架的 PPA,以及杯内的环氧树脂部分。

The epoxy resin of the SMD LED should not contact the tip of the soldering iron.

11.2.3.焊接期间，不可以对器件施加机械压力。

No mechanical stress should be exerted on the resin portion by the tip of the soldering iron.

11.2.4.当焊接好之后，要让它冷却下来到温度低于 40°C才可以进行其他作业。

After soldering, do not deal with the product before its temperature drop down to 40°C

12.使用注意事项/Precautions For Use:**12.1.清洁方法/ Clean Method:**

不要使用不明化学液体清洗产品：不明的化学液体可能会损坏产品。当必要清洗时，把产品用酒精擦拭，并且自然干燥 15 分钟，然后才开始使用。

Do not use unknown chemical liquid to clean the product: unknown chemical liquid may damage the product. When cleaning is necessary, wipe the product with alcohol and dry it for 15 minutes before use.

12.2.防潮湿包装方法/ Moisture Proof Packaging Method:

为避免产品在运输及储存中吸湿,产品的包装是用防潮的铝箔袋包装，并且包装袋里面含有干燥剂，干燥剂主要起到控制包装袋里的湿度。

In order to avoid moisture absorption during transportation and storage, the product is packed in moisture-proof aluminum foil bag, and the bag contains desiccant, which mainly controls the humidity in the bag.

12.3. 储存及使用方法/ Storage And Method Of Application:

SMD LED 产品对潮湿极度敏感。为确保产品回流后保持更长久稳定的品质，请客户按以下要求使用：

SMD LED products are extremely sensitive to humidity. In order to ensure long-term and stable quality after reflow , please use according to the following requirements:

12.3.1 未开封的产品需储存于：温度 30°C以内、湿度 60%RH 以下的环境，且 6 个月内用完。

Unopened products should be stored in the environment of temperature below 30°C / humidity below 60% RH and used up within 6 months.

12.3.2 在开包装之前，请先检查包装袋有无漏气，如果有漏气现象，请退回我司重新烘烤除湿包装后再使用。
Before opening the package, please check the package for air leaks, if there exists any air leaks, please return the product to our company for rework.

12.3.3 开封后请在以下条件使用：温度< 30°C、湿度 60%RH 以下使用，并于 10 小时内完成贴片，如果超过 10 小时未用完，须将产品重新烘烤使用。

Before soldering ,the product must be stored under the condition of <30°C and <60% RH. Under these conditions the SMD LEDs must be used (subject to reflow oven) within 10 hours. If unpacked material is not used up for over 10HR, it need to be re-baked before its using.

12.3.4 烘烤条件如下：

2 个月以内（未受潮）：(65±5) °C×12h；

大于 2 个月小于 6 个月（未受潮）：(65±5) °C×24h；

如果确认灯珠已受潮，或包装袋破损漏气:返回我司重新除湿包装。

Baking condition:

Within 2 months (undamped): (65±5) °C×12h;

Over 2 months within 6 months (undamped): (65±5) °C×24h;

Damped/Foiled bag leakage: Return the product to company for dehumidification and Repackaging

12.4. 静电/ Static Electricity:

12.4.1 静电和电涌会导致产品特性发生改变，例如正向电压降低等，如果情况严重甚至会损毁产品。所以在使用时必须采取有效的防静电措施。

Static electricity or surge voltage damages the LEDs. Damaged LEDs will show some unusual characteristics such as the forward voltage becomes lower, or the LEDs can not be lighted up. In view of the above, we should do some

anti-static precautions when using the SMD LEDs.

12.4.2 使用防静电之手环/垫子/工作服/工作鞋/手套/防静电容器，可以用来防止静电。

It is also recommended that anti-electrostatic wrist bands, pads, uniforms, gloves or containers can be used when dealing with the LEDs.

12.4.3 所有相关的设备和机器都应该正确接地，同时必须采取其他防止静电的措施。

All devices, equipments and machineries must be properly grounded, at the same time we should take measures to prevent anti-static and voltage surge.

12.5.温度保护/ The Safe Temperature For LEDs Working:

LED 在高温条件下，衰减会加速，本身应力也会增大，若长期处于高温环境下，极容易出现失效。

对于高密度排列使用的情况，建议在使用过程中灯面温度不超过 50°C，灯脚温度不超过 70°C。

The high temperature will make the LEDs' Luminous Intensity decreased radically, if LEDs are used in hot environment for a long time, they will be disabled easily. When LEDs are used in a high density array, we suggest that the LEDs' surface temperature should be lower than 50°C and the legs' temperature should be lower than 70°C.

12.6.反向电压控制/ Reverse Voltage Control:

如果 LED 长期遭受超过其所能承受的反向电压冲击时，LED 会被损伤，反向漏电流会变大。这样会引起显示屏零灰度下串光的发生。在设计中，要注意控制反向电压，建议加在 LED 上的反向电压值不超过 5V。

LED is often suffered the reverse voltage which exceeds the limit of the component then it will be damaged. Such as the reverse current increase rapidly. And it will cause the string light when the screen is black. So please pay attention to controlling the reverse voltage which less than 5V is recommended.

修订记录 Revision History

版本 Version	日期 Date	变更 Change
A	2024/10/06	初始版本